

Designing for the Future



ARCHITECTURAL Design Solutions





PROJECT: Syracuse High School LOCATION: Syracuse, UT PANEL PROFILE: 7.2 Panel & Artisan® Series COLOR: Silver Metallic & Black Metallic

Contents

4	Product Application Chart & Index
7	Standing Seam Metal Roofing
11	Insulated Metal Panels
17	Concealed Fastening Systems
20	Interior Wall & Liner Panels
21	Underhung Canopies
22	Soffits
23	Exposed Fastening Systems
26	Structural Systems
27	Retrofit Solutions
29	Service That Makes a Difference

Cover Top Photo

PROJECT: *New Hampshire Technical Institute Student Center* **LOCATION:** *Concord, NH* **PANEL PROFILE:** *PBC* **COLOR:** *Galvalume®*

Cover Bottom Photo

PROJECT: *Teton Science School* **LOCATION:** *Jackson, WY* **PANEL PROFILE:** *SuperLok® Series* **COLOR:** *Zactique II*

Product Application Chart & Index

	ROOF SYSTEM	FACADE SYSTEM	EXTERIOR WALL	INTERIOR WALL LINER	CANOPY ROOF SYSTEM	SOFFIT SYSTEM	CURVED ROOFS	EQUIPMENT SCREENS	FRAMING SYSTEMS	PAGE NUMBER
VERTICAL LEG SSR	■									8
TRAPEZOIDAL SSR	■									10
CURVED BATTENLOK						■				9
INSULATED ROOF PANELS	■									12
INSULATED WALL PANELS			■							13
7.2 PANEL	■	■	■				■			24
CRAFTSMAN™	■	■				■				18
FW-120		■	■		■		■			19
IL				■						20
SHADOWRIB™		■	■				■			19
NUWALL®		■	■				■			19
DESIGNER® SERIES		■	■				■			18
MASTERLINE 16			■	■			■			19
QWIKLOK™				■	■					21
CLASSIC®				■	■					21
ARTISAN®			■		■					22
FLEXLOC®	■				■	■	■			22
LITEFRAME®								■		26
NUROOF®								■		28

MBCI has earned its reputation as one of the nation's leading suppliers of preformed metal for roofs, walls, mansards and soffits by providing the highest quality building components and service in the industry.

This Product Application Chart is for general reference only. Not all panels, gauges and widths should be used for these applications. Please call MBCI for the best product for your specific application.

Descriptions and specifications contained herein were in effect at the time this publication was approved for printing. In a continuing effort to refine and improve products, MBCI reserves the right to discontinue products at any time or change specifications and/or designs without incurring obligation. To ensure you have the latest information available, please inquire or visit our website at www.mbc.com. Application details are for illustration purposes only and may not be appropriate for all environmental conditions, building designs or panel profiles. Projects should be designed to conform to applicable building codes, regulations and accepted industry practices. If there is a conflict between this manual and project erection drawings, the erection drawings will take precedence. MBCI's insulated metal panel product line is manufactured by Metl-Span.

STIMULATE YOUR IMAGINATION

WITH MBCI'S BROAD SPECTRUM OF PANEL OFFERINGS, DESIGN OPPORTUNITIES ARE EXPONENTIAL. PRODUCT OFFERINGS RANGING FROM SINGLE SKIN ROOF AND WALL PANELS TO INSULATED METAL PANELS, SOLUTIONS FOR NEW AND RETROFIT CONSTRUCTION, COATINGS IN A BREADTH OF COLORS AND APPLIED FINISHES PROVIDE YOU INSPIRATION TO **DESIGN YOUR MASTERPIECE.**

THE MBCI ADVANTAGE

Since 1976, MBCI has been dedicated to providing our customers with the highest quality products and excellent service from our skilled professionals. MBCI is the industry-leading manufacturer of metal roof and wall systems, supplying products to the architectural, institutional, commercial, industrial, residential and agricultural markets. MBCI has facilities positioned strategically throughout the United States to best serve our customers.

*The industry-leading manufacturer
of metal roof and wall systems.*

STIMULATE YOUR IMAGINATION
STIMULATE YOUR IMAGINATION



Standing Seam Metal Roofing

When your design requires a roofing system that is both aesthetically pleasing and structurally sound, choose one of MBCI's standing seam metal roof (SSR) systems. Our SSR systems are some of the most durable and weathertight roof systems available in the industry, providing longevity while enhancing the appearance of the building.

MBCI offers two types of standing seam metal roofs: vertical leg structural and trapezoidal structural. Each system carries the Underwriters Laboratories Wind Uplift (UL 90), Fire Resistance and Impact Resistance ratings covering a wide range of roof designs. Additional ratings have been given to the individual panel systems.

Special clips are available for thermal roof expansion and contraction during extreme temperature changes. All trim is both weathertight and aesthetically pleasing, giving the roof a clean, finished appearance.



Vertical Leg Structural Standing Seam Metal Roof Systems

The vertical leg systems blend the aesthetics of an architectural panel with the strength of a structural panel. These panels have earned several UL uplift ratings, assuring reliability of performance, while also providing flexibility to meet design challenges.

Each of these SSR systems is designed to be installed over open framing. However, the MBCI LiteFrame®, $\frac{5}{8}$ " plywood or a composite roof assembly may be used as an alternate substructure.



PROJECT: Audubon National Wildlife Refuge **LOCATION:** Coal Harbor, ND **PANEL PROFILE:** BattenLok® HS **COLOR:** Classic Green

LOKSEAM®

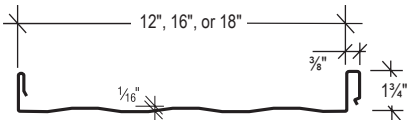
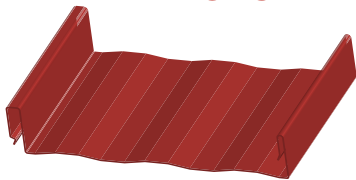

LokSeam® is a snap-together standing seam roof system with a $\frac{1}{4}$ " tall vertical rib for use on roofs with a minimum slope of 3:12. Available in 12-inch, 16-inch and 18-inch widths, LokSeam® panels can be installed over open framing or a solid substructure and are capable of transitioning from roof to fascia with the use of a rib cover. LokSeam® does not require a solid substructure for support.

Product Specifications

- **Application:** Roof
- **Coverage Widths:** 12", 16", 18"
- **Minimum Slope:** 3:12
- **Panel Attachment:** Concealed Fastening System, Standard and UL 90 Clips
- **Gauges:** 24 (standard); 22 (12", 16", 18"), 26 (12") (optional)
- **Finishes:** Striated (standard); Embossed Striated (optional)
- **Coatings:** Galvalume Plus®, Signature® 200, Signature® 300, Signature® 300 Metallic

SUPERLOK®

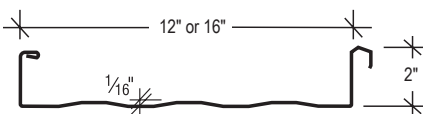
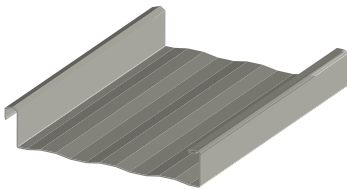

SuperLok® is a mechanically field-seamed system that combines a 2" tall slim rib with exceptional uplift resistance. MBCI designed the SuperLok® system to withstand the most rigorous weather conditions. This panel can be installed directly over purlins or bar joists, and does not require a solid substructure for support.

In addition to the UL 90 rating, the SuperLok® system meets a variety of ratings as tested under FM Global Corporation Standard 4471.

Product Specifications

- **Application:** Roof
- **Coverage Widths:** 12", 16"
- **Minimum Slope:** $\frac{1}{2}$:12
- **Panel Attachment:** Concealed Fastening System, Low, High (fixed or floating), Utility (no insulation clearance)
- **Gauges:** 24 (standard); 22, 26 (optional)
- **Finishes:** Smooth Striated (standard); Embossed Striated (optional)
- **Coatings:** Galvalume Plus®, Signature® 200, Signature® 300, Signature® 300 Metallic

PROJECT: Owens Community College LOCATION: Fredericktown, OH PANEL PROFILE: Curved BattenLok® COLOR: Colonial Red

BATTENLOK® HS

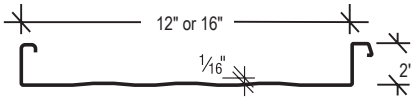
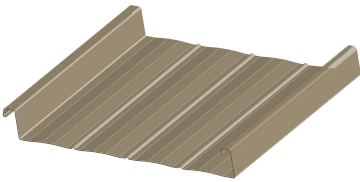

BattenLok® HS is a mechanically field-seamed, high strength structural standing seam roof system. The BattenLok® HS panels have a two-inch tall vertical seam and are available in both 12-inch and 16-inch widths. BattenLok® HS can be installed directly over purlins or bar joists and is capable of transitioning from roof to fascia. BattenLok® HS does not require a solid substructure for support.

Product Specifications

- **Application:** Roof
- **Coverage Widths:** 12", 16"
- **Minimum Slope:** ½:12
- **Panel Attachment:** Concealed Fastening System, Low, High (fixed or floating), Utility (no insulation clearance)
- **Gauges:** 24 (standard); 22 (optional)
- **Finishes:** Smooth or Embossed; with Striations or Striations with Pencil Ribs (16" only)
- **Coatings:** Galvalume Plus®, Signature® 200, Signature® 300, Signature® 300 Metallic

CURVED BATTENLOK®

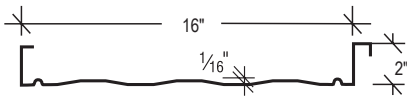

When your roof calls for a curved standing seam metal roof, Curved BattenLok® is an ideal choice. The Curved BattenLok® profile is a water shedding, curved standing seam metal roof system with a two-inch tall standing seam that is field-seamed during the installation process. Striations are standard and added for aesthetic value.

Curved BattenLok® is a structural roofing panel that may be curved to a minimum radius of 20 feet and can be installed directly over purlins or joists. This curved standing seam metal roof system can also be installed over wood decks and metal decks with rigid insulation. Open framing applications eliminate costly curved deck surfaces and membrane underlayments. For large projects and/or long panels, the curving process for the curved standing seam metal roof system may best be accomplished at the job site.

Product Specifications

- **Application:** Roof
- **Coverage Width:** 16"
- **Panel Attachment:** Concealed Fastening System, Low, High (fixed or floating), Utility (no insulation clearance)
- **Gauges:** 24 (standard); 22 (optional)
- **Finishes:** Smooth Striated (standard)
- **Coatings:** Galvalume Plus®, Signature® 200, Signature® 300

Trapezoidal Standing Seam Metal Roof Systems

The trapezoidal SSR systems are designed for strength, durability and weatherability. The standing seams are 3" above the lowest part of the panel, well above the water level as it flows off the roof. The rake/gable at both ends of each roof system eliminates the necessity of finishing in the low, flat part of the panel where the greatest possibilities for leaks occur in many other systems.

The trapezoidal SSR systems can be installed before or after the exterior walls are in place. All trim is attached after the roof is installed. With a recommended minimum slope of ¼:12, these systems can be used on all types of construction, including metal, masonry or wood for either new or retrofit construction.



C PROJECT: UDOT Strawberry Maintenance Station **LOCATION:** West Valley, UT **PANEL PROFILE:** Double-Lok® & Artisan® Series **COLOR:** Champagne Metallic

ULTRA-DEK®

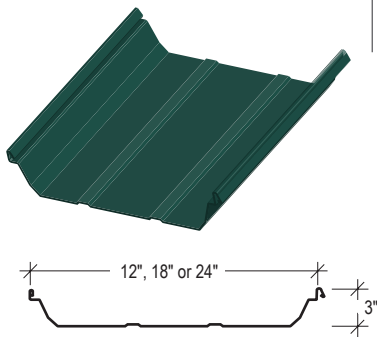

The Ultra-Dek® roof panel is a snap-together, trapezoidal leg standing seam roof system. Ultra-Dek® panels are available in 12-inch, 18-inch and 24-inch widths. Ultra-Dek® requires a minimum slope of ¼:12 and is ideal for industrial, commercial and architectural applications. Ultra-Dek® can be erected on various types of construction.

Product Specifications

- **Application:** Roof
- **Coverage Widths:** 12", 18", 24"
- **Minimum Slope:** ¼:12
- **Panel Attachment:** Concealed Fastening System, Low, High (fixed or sliding)
- **Gauges:** 24 (standard); 22, 26 (optional)
- **Finishes:** Smooth (standard); Embossed (optional)
- **Coatings:** Galvalume Plus®, Signature® 200, Signature® 300, Signature® 300 Metallic

DOUBLE-LOK®

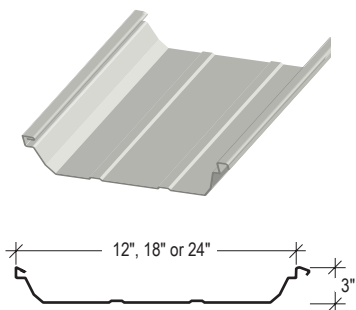

The Double-Lok® roof panel is a mechanically field-seamed, trapezoidal leg standing seam roof system. Double-Lok® panels are available in 12-inch, 18-inch and 24-inch widths and require a minimum slope of ¼:12. Double-Lok® panels are ideal for industrial, commercial and architectural applications.

Product Specifications

- **Application:** Roof
- **Coverage Widths:** 12", 18", 24"
- **Minimum Slope:** ¼:12
- **Panel Attachment:** Concealed Fastening System, Low, High, Fixed and Sliding and a 2" Stand off Clip
- **Gauges:** 22, 24
- **Finishes:** Smooth (standard); Embossed (optional)
- **Coatings:** Galvalume Plus®, Signature® 200, Signature® 300, Signature® 300 Metallic



PROJECT: Fujisawa Healthcare Inc. **LOCATION:** Grand Island, NY **PANEL PROFILE:** CF Architectural/Horizontal **COLOR:** Silver Metallic

Insulated Metal Panels

MBCI's insulated metal panels, manufactured by Metl-Span, deliver both attractiveness and energy-efficiency to a building's design. As building and energy codes become increasingly more stringent, insulated panels are particularly advantageous in achieving sustainable design and code compliance.

Insulated metal panels (IMPs) present many advantages for building owners, designers and contractors, including improved thermal performance, excellent insulating capabilities, reduced building operational expenses, accelerated construction schedules, earlier business starts and much more. Available in a wide variety of panel profiles, colors and applied finishes, IMPs are ideal for architectural, commercial, industrial and institutional applications.



PROJECT: Armstrong Way LOCATION: Plymouth, MA PANEL PROFILE: Striated COLOR: Bright Silver

LS-36™

The versatility of the LS-36™ panel offers a multitude of design options and can be utilized for roof or wall applications. The standard exterior skin is smooth but can be embossed if requested, while the interior skin is roll-formed with our standard stucco-embossed Mesa profile.

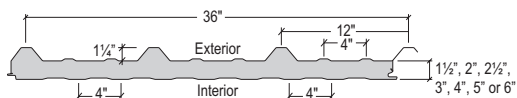
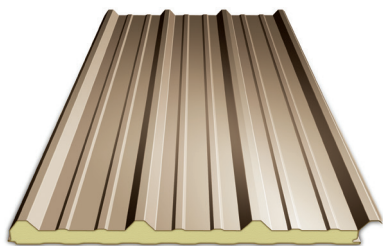

Product Specifications

- **Applications:** Roof and Wall
- **Gauges:** Exterior: 26, 24, 22 | Interior: 26, 24, 22
- **Width:** 36"
- **Thicknesses:** 1 1/2", 2", 2 1/2", 3", 4", 5", 6"
- **Length:** Recommended maximum of 50'
- **Panel Attachment:** Exposed Fastening System
- **Standard Coatings:** Galvalume Plus®, Signature® 200, Signature® 300, Signature® 300 Metallic, Applied Finishes (wall application only)

CFR

CFR is an insulated metal standing seam roof panel and is the newest innovation in all-in-one composite roof panel design, combining durable interior and exterior faces with an unmatched polyurethane core. The CFR panel is a truly unique answer to many deficiencies common with more traditional roofing materials of the past.

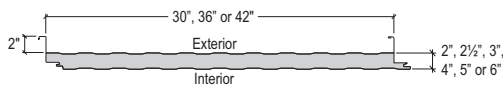
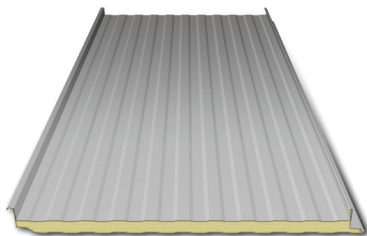

Product Specifications

- **Applications:** Roof
- **Gauges:** Exterior: 24, 22 | Interior: 26, 24, 22
- **Width:** 42" (standard); 30", 36" (optional)
- **Thicknesses:** 2", 2 1/2", 3", 4", 5", 6"
- **Length:** Recommended maximum of 50'
- **Panel Attachment:** Concealed Fastening System
- **Standard Coatings:** Galvalume Plus®, Signature® 200, Signature® 300

CF45 PARTITION WALL

The CF45 Partition Wall panel is the optimal choice for interior partitions. The interior and exterior panel faces are identical images with the same profile for each. This panel is available in a width of 44½", and the profiles have ⅛" ribs that are four inches on center.

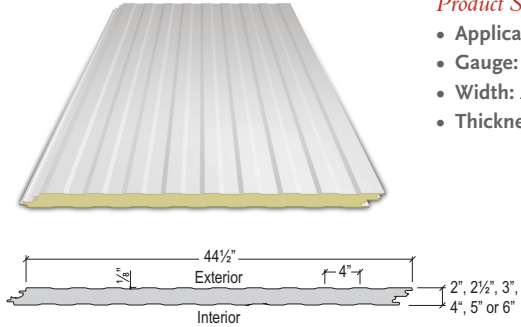

Product Specifications

- **Applications:** Wall (interior only)
- **Gauge:** 26, 24, 22 (both surfaces)
- **Width:** 44½"
- **Thicknesses:** 2", 2½", 3", 4", 5", 6"
- **Length:** Recommended maximum of 50'
- **Panel Attachment:** Tongue-and-Groove with Exposed Fasteners
- **Standard Coating:** Igloo White

CF MESA

The CF Mesa panel is designed for exterior wall applications, interior wall partitions and interior ceilings. The lightly corrugated profile on both faces of the panel carries symmetry from the building's exterior through its interior, and from room to room in partition installations. This panel is most commonly used for commercial applications.

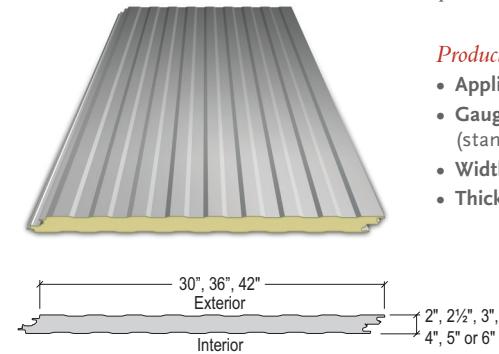

Product Specifications

- **Application:** Wall (vertical)
- **Gauges:** Exterior: 26, 24, 22 | Interior: 26 (standard); 24, 22 (optional)
- **Widths:** 30", 36", 42"
- **Thicknesses:** 2", 2½", 3", 4", 5", 6"
- **Length:** Recommended maximum of 50'
- **Panel Attachment:** Concealed Fastening System
- **Standard Coatings:** Signature® 200, Signature® 300, Signature® 300 Metallic, Applied Finishes

CF ARCHITECTURAL & CF ARCHITECTURAL/HORIZONTAL

The CF Architectural (vertical) and CF Architectural/Horizontal wall panel employs a flat appearance providing a monolithic look that is great for high-profile architectural applications. The panel allows designers to mix multiple panel widths and colors on the same wall. It also allows flexibility for continuous corners along with a complete line of aluminum extrusions and accessories to complete the wall system. When desired, these panels can also be mixed with vertical or horizontal panels to achieve almost any look a design requires, and can be used in vertical or horizontal applications.

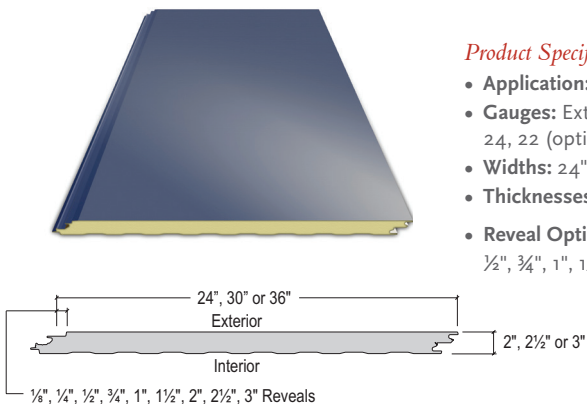

Product Specifications

- **Application:** Wall (vertical and horizontal)
- **Gauges:** Exterior: 22 | Interior: 26 (standard); 24, 22 (optional)
- **Widths:** 24", 30", 36"
- **Thicknesses:** 2", 2½", 3" (4" available for vertical)
- **Reveal Options (horizontal):** ⅛" (standard); ¼", ½", ¾", 1", 1½", 2", 2½", 3" (optional)
- **Length:** Recommended maximum of 32' for vertical and 24' for horizontal
- **Panel Attachment:** Concealed Fastening System
- **Standard Coatings:** Signature® 300, Signature® 300 Metallic



PROJECT: Baker Hughes Research and Technology Center LOCATION: Claremore, OK PANEL PROFILE: LS-36™ & CF Mesa COLOR: Tundra & Limestone

CF FLUTE

The traditional styling and distinct vertical lines of the CF Flute panel are ideal for custom-designed or conventional building construction, especially commercial and industrial applications, as well as cold storage. The interior skin employs a stucco-embossed Mesa profile.

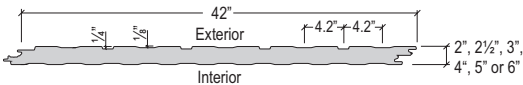
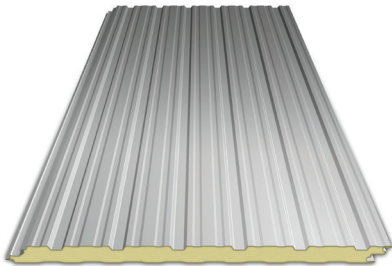

Product Specifications

- **Application:** Wall (vertical)
- **Gauges:** Exterior: 26, 24, 22 | Interior: 26 (standard); 24, 22 (optional)
- **Width:** 42"
- **Thicknesses:** 2", 2½", 3", 4", 5", 6"

- **Length:** Recommended maximum is 50'
- **Panel Attachment:** Concealed Fastening System
- **Standard Coatings:** Signature® 200, Signature® 300, Signature® 300 Metallic

SANTA FE®

The Santa Fe® exterior skin has a flat exterior profile with an Aztec-embossed pattern resembling old-world hand plaster. The interior skin employs a stucco-embossed light Mesa profile.

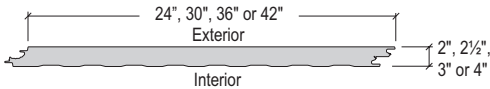
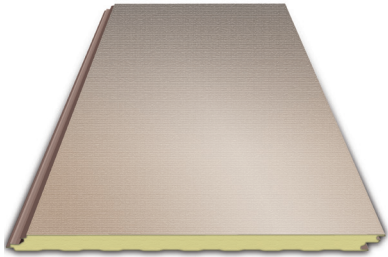

Product Specifications

- **Application:** Wall (vertical or horizontal)
- **Gauges:** Exterior: 24, 22 | Interior: 26 (standard); 24, 22 (optional)
- **Widths:** 24", 30", 36", 42"
- **Thicknesses:** 2", 2½", 3", 4"

- **Length:** Recommended maximum is 40'
- **Panel Attachment:** Concealed Fastening System
- **Standard Coatings:** Signature® 200, Signature® 300, Signature® 300 Metallic, Applied Finishes

STRIATED

The exterior skin of the Striated panel is profiled with minor striations, giving it a flat look and providing a linear appearance while blending with the panel side joints. This panel is an excellent alternative to typical flat wall panels. The interior skin has a stucco-embossed light Mesa profile.

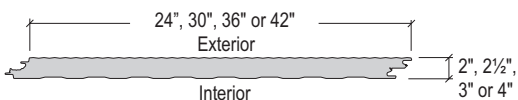
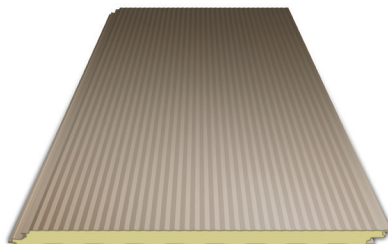

Product Specifications

- **Application:** Wall (vertical or horizontal)
- **Gauges:** Exterior: 24, 22 | Interior: 26 (standard); 24, 22 (optional)
- **Widths:** 24", 30", 36", 42"
- **Thicknesses:** 2", 2½", 3", 4"

- **Length:** Recommended maximum is 32' for 42" width, and 40' for 24", 30" and 36" widths
- **Panel Attachment:** Concealed Fastening System
- **Standard Coatings:** Signature® 200, Signature® 300, Signature® 300 Metallic, Applied Finishes

7.2 INSUL-RIB™

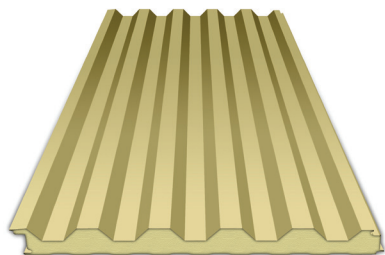

The 7.2 Insul-Rib™ panel combines a traditional 7.2 rib panel design with a premier polyurethane foam core. This panel can be installed both vertically and horizontally, allowing architects the same design flexibility that is available with our single skin 7.2 Panel (page 24).

Product Specifications

- **Application:** Wall (vertical or horizontal)
- **Gauges:** Exterior: 26, 24, 22 | Interior: 26, 24, 22
- **Width:** 36"
- **Thicknesses:** 3", 4", 5", 6"
- **Length:** Recommended maximum of 40'
- **Panel Attachment:** Offset double tongue-and-groove with extended metal shelf for positive concealed face fastening
- **Standard Coatings:** Signature® 200, Signature® 300, Signature® 300 Metallic

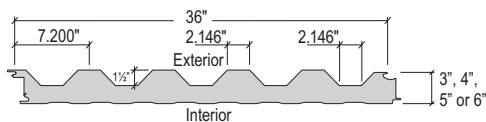

TUFF WALL® / TUFF-CAST™

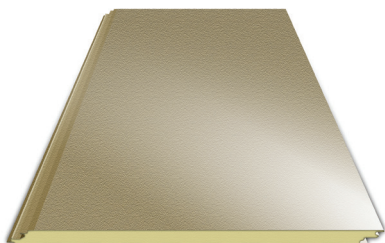

The Tuff Wall® and Tuff-Cast™ panels are designed for exterior applications where an aggregate look is preferred. The exterior skin of the panel is embossed flat, while the interior skin has the embossed light Mesa profile. Tuff Wall® has a finish similar to stucco, providing the masonry look many designers and communities desire. The Tuff-Cast™ exterior is finished with look of precast concrete.

Product Specifications

- **Application:** Wall (vertical and horizontal)
- **Gauges:** Exterior: 24, 22 | Interior: 26, 24, 22
- **Widths:** 36", 42"
- **Thicknesses:** 2", 2½", 3", 4"
- **Length:** Recommended maximum is 38'
- **Panel Attachment:** Concealed Fastening System
- **Standard Coatings:** Applied Finishes only

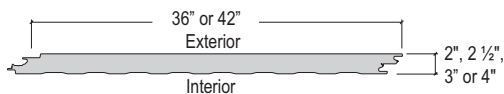



HPCI BARRIER™

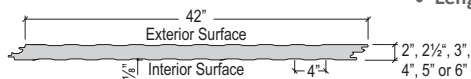
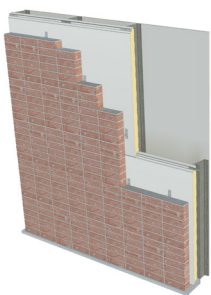

The HPCI Barrier™ insulated metal panel is an air, water, thermal and vapor barrier panel that can be used behind any type of façade. This back-up panel may be installed in a horizontal or vertical orientation completely outside the structural supports. There are no thermal bridges to reduce the energy efficiency of the wall. HPCI Barrier™ is quick and easy to install and provides an economical solution to conventional air, water, thermal and vapor control without sacrificing thermal efficiency. This panel must be separated from the interior of the building by an approved thermal barrier of .5" (12.7 mm) gypsum wallboard to meet IBC requirements.

Product Specifications

- **Application:** Wall (vertical or horizontal)
- **Exterior and Interior Gauges:** 26
- **Width:** 42"
- **Thicknesses:** 2", 2½", 3", 4", 5" and 6"
- **Length:** Recommended maximum of 24'

- **Insulation Material:** Zero ozone depleting polyurethane
- **Panel Attachment:** Tongue-and-Groove, Concealed Fastener
- **Standard Coating:** Signature® 200 Igloo White (straight polyester)

THERMALSAFE®

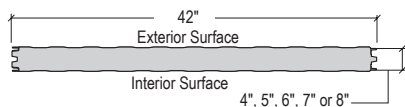
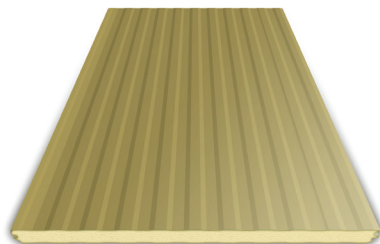

The ThermalSafe® panel consists of metal facings bonded to a structural mineral wool core to create a composite panel that achieves fire resistance ratings under the most demanding conditions. Unlike traditional wall materials, ThermalSafe® offers a level of flexibility architects, contractors and building owners won't find in any other product in the U.S. The mineral wool panel is rated for its one-, two- and three-hour fire resistance qualities and provides satisfactory thermal performance and protection from the elements. The R-value of this panel is 3.61 per inch of insulation.

Fire Resistant Data

- The finished panel in four-inch thickness for one-hour, seven-inch thickness for two-hour and eight-inch thickness for three-hour Fire Resistant ratings for nonbearing walls in accordance with UL 263 Fire Endurance tests and ASTM E119 tests
- For more complete Fire Resistant rating data, including Fire Resistant ratings for pipe penetrations both metallic and non-metallic, ducts and fire door and window assembly design installed in an ThermalSafe® wall, go to www.mbc.com and follow links to Fire Resistant approvals data.
- Wall-framing support members and adjacent construction may require fire protection as specified by applicable building code. The customer is responsible for specifying the appropriate fire protection of these areas.

Features & Benefits

- Resists high temperatures and will not burn because of mineral wool core
- Can be disassembled, moved and reinstalled rather than having to be demolished, waste materials disposed of and the walls completely rebuilt
- Our exclusive integral spline design eliminates labor to install a separate cement board spline at side joint of panels to maintain the fire rating
- Good sound reduction acoustic properties because of mineral wool
- Dimensionally stable, water repellent and will not expand
- Can be combined with other MBCI panels for an aesthetically consistent profile facing, texture and color

Product Specifications

- **Application:** Wall (vertical or horizontal)
- **Gauges:** Exterior: 26, 24 | Interior: 26, 24
- **Width:** 42"
- **Thicknesses:** 4", 5", 6", 7" and 8"
- **Length:** Recommended maximum of 40'; Maximum available length may be reduced due to panel thickness, end use and orientation

- **Panel Attachment:** Exposed Fastening System
- **Standard Coatings:** Signature® 200, Signature® 300, Signature® 300 Metallic

Concealed Fastening Systems





CRAFTSMAN™ SERIES

The Craftsman™ Series is a snap-on batten roof system, available in narrow, wide and high profiles: small (SB) and high batten (HB).

The Craftsman™ Series is a water-shedding system and can be used for roofs and fascias only when installed over a water-proofed solid substructure with a minimum roof slope of 3:12. The Craftsman™ Series design makes complicated building transitions simple without the necessity of flashings. Slope changes from roof to fascia to soffit can be made with one continuous pan and batten.

Product Specifications

- **Application:** Roof, Fascia
- **Coverage Widths:** 12", 16½"
- **Minimum Slope:** 3:12
- **Panel Attachment:** Concealed Fastening System
- **Gauges:** 24 (standard); 22, 26 (optional)
- **Finishes:** Smooth (standard); Striated (optional)
- **Coatings:** Galvalume Plus®, Signature® 200, Signature® 300, Signature® 300 Metallic

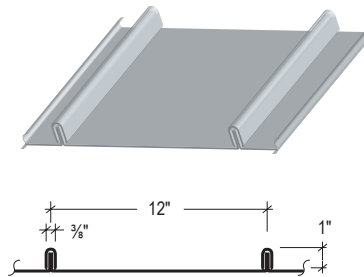

SB-12

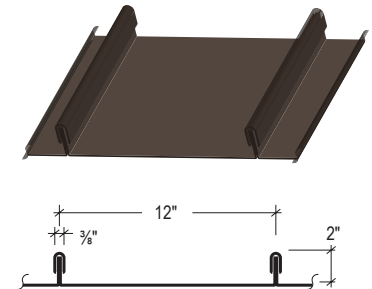

HB-12

DESIGNER™ SERIES

The Designer™ Series panels provide the toughness of metal while creating an attractive, flexible and functional wall or fascia panel. The Designer™ Series is offered in fluted and flat panels, which are equally effective for new construction or retrofitting existing buildings.

If your design calls for a smooth or flat wall or fascia, look to the Designer™ Series 12.0 Flat Panel, which offers a 1¾-inch deep leg providing the perfect cavity for rigid board insulation.

Product Specifications

- **Application:** Wall
- **Coverage Widths:** 12" (flat), 16" (fluted)
- **Panel Attachment:** Concealed Fastening System
- **Gauges:** 24 (standard); 22 (optional)
- **Finishes:** Smooth (standard); Embossed (optional)
- **Coatings:** Galvalume Plus®, Signature® 200, Signature® 300, Signature® 300 Metallic

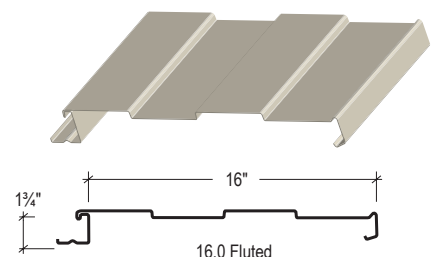
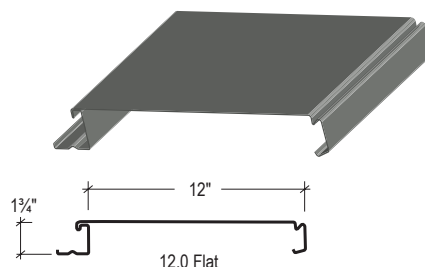

MASTERLINE 16

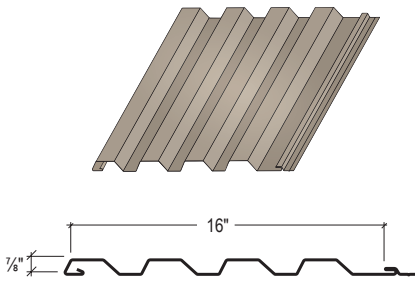

MasterLine 16 is a concealed-fastened metal wall panel that provides an interesting shadow line, enhancing the aesthetics of the panel. While primarily designed for horizontal applications, it can also be installed vertically to give a distinguished architectural design. The panels provide 16-inch coverage and are available with factory-applied mastic in the side laps. Panels may be attached to metal studs, with or without sheathing, as well as to subgirts.

Product Specifications

- **Application:** Wall
- **Coverage Width:** 16"
- **Panel Attachment:** Concealed Fastening System
- **Gauges:** 24 (standard); 22, 20, 18 (optional)
- **Finishes:** Smooth (standard); Embossed (optional; 24 and 22 gauge only)
- **Coatings:** Galvalume Plus®, Signature® 200, Signature® 300, Signature® 300 Metallic

SHADOWRIB™

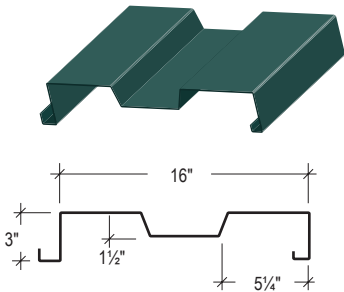

ShadowRib™ is a three-inch deep panel that combines aesthetics, economy and function to bring definition to metal structures. ShadowRib™ is a proven performer and a versatile tool to the designer. Structural strength in the ShadowRib™ panel is accomplished without sacrificing appearance or design flexibility. The fluted face creates distinctive shadow lines.

Product Specifications

- **Application:** Wall
- **Coverage Width:** 16"
- **Panel Attachment:** Concealed Fastening System (outside); ShadowRib™ Panel Clip (inside)
- **Gauges:** 24 (standard); 22 (optional)
- **Finishes:** Smooth (standard); Embossed (optional)
- **Coatings:** Galvalume Plus®, Signature® 200, Signature® 300, Signature® 300 Metallic

NUWALL®

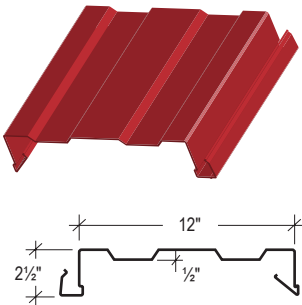

The NuWall® wall panel can be used for either new or retrofit construction. This concealed-fastened system creates a clean, uninterrupted wall on a building.

Product Specifications

- **Application:** Wall
- **Coverage Width:** 12"
- **Panel Attachment:** Concealed Fastening System
- **Gauges:** 24 (standard); 22 (optional)
- **Finishes:** Smooth (standard); Embossed (optional)
- **Coatings:** Galvalume Plus®, Signature® 200, Signature® 300, Signature® 300 Metallic

FW-120

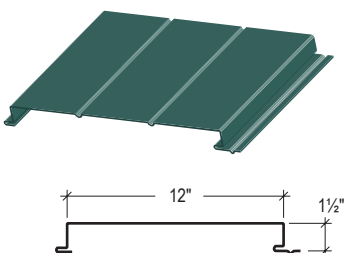

The FW-120 panel is a concealed-fastened wall and liner panel that provides a flat appearance. FW-120 is commonly used for architectural, commercial and industrial markets. The heavy gauge offering provides for large spanning capabilities, particularly in composite wall applications.

Product Specifications

- **Application:** Wall, Fascia
- **Coverage Width:** 12"
- **Panel Attachment:** Concealed Fastening System
- **Gauges:** 24 (standard); 22, 20 (optional)
- **Finishes:** Smooth (standard); Embossed (optional)
- **Coating:** Signature® 300

Interior Wall & Liner Panels



PROJECT: Experience Life Now Church **LOCATION:** Lubbock, TX **PANEL PROFILE:** FW-120 **COLOR:** Galvalume®

These concealed-fastened interior wall and liner panels offer an attractive, flat appearance for architectural, commercial and industrial markets. The FW-120 panel can be used as an interior wall or liner panel. The IL panel is available with face beads and/or embossing to minimize the potential for oil canning.

Field-Assembled Composite Wall Systems

The composite wall system is designed to accommodate FW or 7.2 panels as exterior skins with IL panel interior liners.

IL PANEL

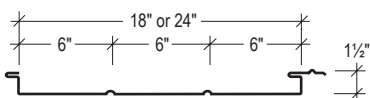
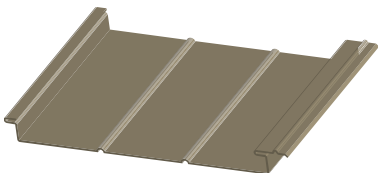

The IL Panel is ideal for an interior liner, creating a rugged and attractive finished wall appearance. This panel features a concealed-fastened system and allows for installation as the liner of a composite wall system or can be installed to the inside girts of a building. The IL Panel is not recommended for exterior wall applications.

Product Specifications

- **Applications:** Interior Wall and Liner
- **Coverage Widths:** 18", 24"
- **Panel Attachment:** Concealed Fastening System
- **Gauges:** 24 (standard); 22 (optional)
- **Finishes:** Smooth (standard); Embossed (optional)
- **Coating:** Signature® 200

Underhung Canopies

MBCI offers two separate panel profiles for underhung canopies, the Classic® Series and QwikLok™.

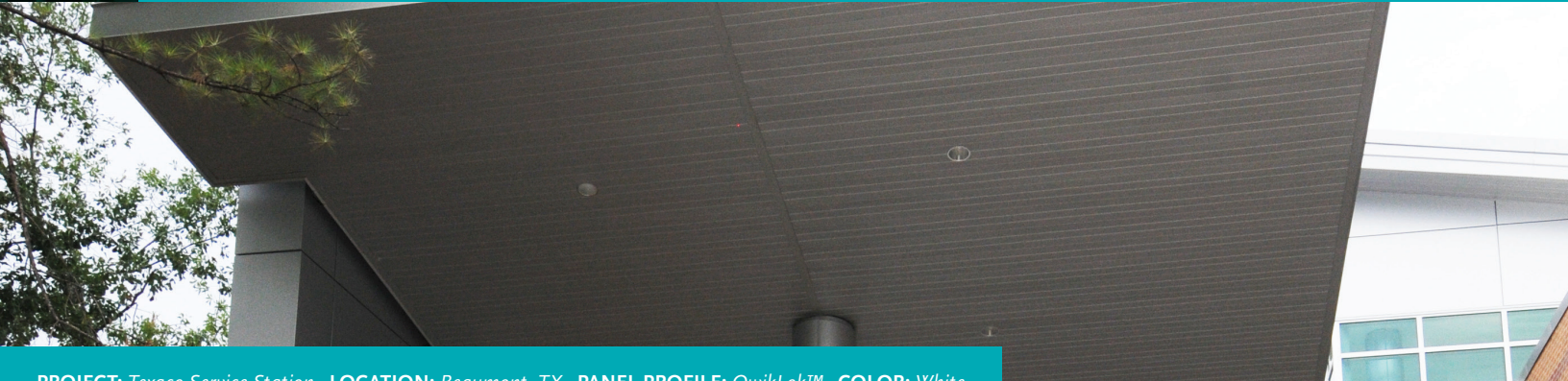

PROJECT: *Texaco Service Station* LOCATION: *Beaumont, TX* PANEL PROFILE: *QwikLok™* COLOR: *White*

CLASSIC® SERIES

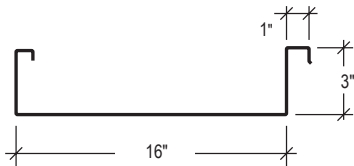
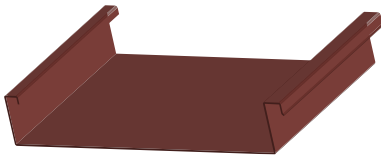

The Classic® Series is a time-tested performer. Through the years, this versatile and valuable panel has been used for canopies, walkway covers and soffits. The Classic® Series creates a clean, flush appearance when used as a canopy system.

Product Specifications

- **Applications:** Canopies, Walkway Covers and Soffits
- **Coverage Widths:** 16"
- **Panel Attachment:** Concealed Fastening System
- **Gauges:** 24 (standard); 22 (optional)
- **Finishes:** Smooth (standard); Embossed (optional)
- **Coatings:** Galvalume Plus®, Signature® 200, Signature® 300, Signature® 300 Metallic

QWIKLOK™

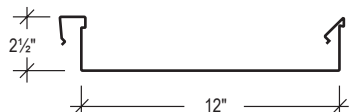
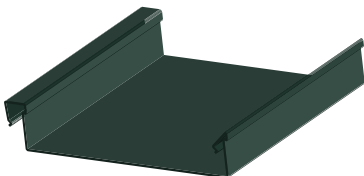

QwikLok™ is ideal for underhung applications; no more fighting with trying to install two panels at one time. Unlike conventional roofing cover, QwikLok™ can be assembled from the underside of the structure one panel at a time, producing a flush appearance with no exposed fasteners.

Product Specifications

- **Applications:** Canopies, Walkway Covers and Soffits
- **Coverage Width:** 12"
- **Panel Attachment:** Concealed Fastening System
- **Gauge:** 24
- **Finishes:** Smooth (standard); Embossed (optional)
- **Coating:** High Gloss White

Soffits

MBCI offers two separate panel profiles to be used as soffits. The Artisan® Series is simplistic and offers uniform dimensions and a clean appearance. The FlexLoc® panel system combines a clean, flat appearance with an easy-to-engage seam.



PROJECT: Champions Academy and Childcare LOCATION: Cypress, TX PANEL PROFILE: Artisan® Series COLOR: Burnished Slate

ARTISAN® SERIES

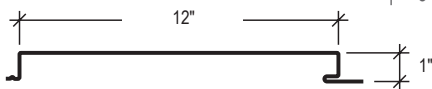

The simplicity of the Artisan® Series panel is its best design feature. Uniform dimensions and a clean appearance allow the designer to plan modules, eliminate complicated pieces and follow wall curvatures. The Artisan® panel can be vertical, horizontal, perpendicular or skewed to the building line, allowing the designer multidimensional freedom to create.

Product Specifications

- **Applications:** Soffits and Interior Liners
- **Coverage Widths:** 12"
- **Panel Attachment:** Concealed Fastening System
- **Gauges:** 24 (standard); 26, 22 (optional)
- **Finishes:** Smooth (standard); Embossed (optional)
- **Coatings:** Galvalume Plus®, Signature® 200, Signature® 300, Signature® 300 Metallic

FLEXLOC®

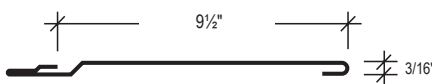

Available in 9½-inch widths, the FlexLoc® panel is clipped down to a waterproofed solid substrate when used in roof applications.

Product Specifications

- **Applications:** Soffits and Curved Applications
- **Coverage Widths:** 9½"
- **Panel Attachment:** Concealed Fastening System
- **Gauges:** 24 (standard); 22 (optional)
- **Finishes:** Smooth (standard); Embossed (optional)
- **Coatings:** Galvalume Plus®, Signature® 200, Signature® 300, Signature® 300 Metallic



Exposed Fastening Systems

MBCI exposed fastening systems help provide contemporary and environmentally-friendly aesthetics. Oftentimes these panels can be installed both vertically and horizontally, giving you numerous options for your design. To see all of our exposed-fastening options, visit us online at www.mbc.com.

7.2 PANEL

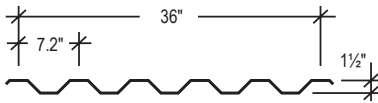
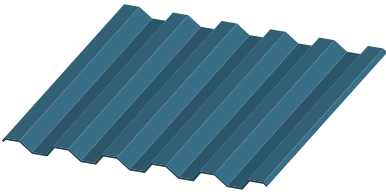

When your design calls for a commercial or industrial exposed fastener panel, the 7.2 Panel is an ideal choice. This panel offers versatility and functionality for roofs and walls. The symmetrical rib 7.2 Panel offers excellent spanning and cantilever capabilities, making it an excellent choice for carports and walkway canopies. When used on walls, the 7.2 Panel is typically ordered as “reverse rolled” and can be installed either vertically or horizontally.

Product Specifications

- **Applications:** Roof and Wall
- **Coverage Width:** 36"
- **Rib Spacing:** 7.2" on Center
- **Rib Height:** 1½"
- **Minimum Slope:** ½:12
- **Panel Attachment:** Exposed Fastening System
- **Gauges:** 24 (standard); 29, 26, 22 (optional)
- **Finishes:** Smooth (standard); Embossed (optional)
- **Coatings:** Galvalume Plus®, Signature® 200, Signature® 300, Signature® 300 Metallic

PBR

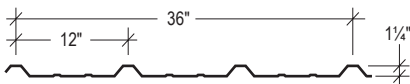
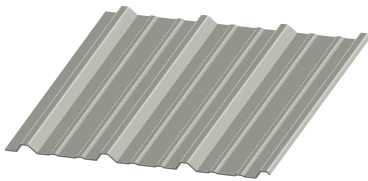

The PBR panel is commonly used for a wide variety of architectural, agricultural, commercial and industrial applications. PBR is a structural, exposed-fastened panel that can be used for both roof and wall applications. The minimum roof slope for PBR is ½:12.

Product Specifications

- **Applications:** Roof and Wall
- **Coverage Width:** 36"
- **Rib Spacing:** 12" on Center
- **Rib Height:** 1¼"
- **Minimum Slope:** ½:12
- **Panel Attachment:** Exposed Fastening System
- **Gauges:** 26 (standard); 22, 24, 29 (optional)
- **Finishes:** Smooth (standard); Embossed (optional)
- **Coatings:** Galvalume Plus®, Signature® 200, Signature® 300

PBC

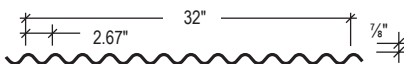
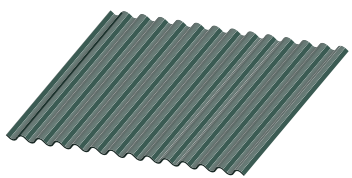

The PBC panels can be used for both roof and wall applications. PBC panels are attached to a building structure with exposed fasteners and is often used in horizontal applications on walls.

Product Specifications

- **Applications:** Roof and Wall
- **Coverage Width:** 32"
- **Rib Spacing:** 2.67" on Center
- **Rib Height:** 7/8"
- **Minimum Slope:** 3:12
- **Panel Attachment:** Exposed Fastening System
- **Gauges:** 26 (standard); 22, 24, 29 (optional)
- **Finishes:** Smooth (standard); Embossed (optional)
- **Coatings:** Galvalume Plus®, Signature® 200, Signature® 300

PBD

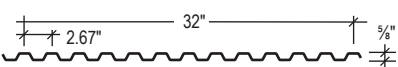
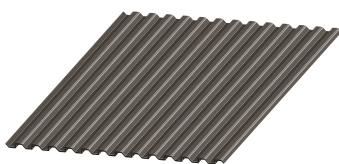

The PBD panel is an exposed-fastened panel system that can be used for roof and wall applications. When used in wall applications, panels can be installed vertically or horizontally. The ribs in the PBD panel are symmetrical from top to bottom, which makes this panel ideal as a roof liner.

Product Specifications

- **Applications:** Roof and Wall
- **Coverage Width:** 32"
- **Rib Spacing:** 2.67" on Center
- **Rib Height:** 5/8"
- **Minimum Slope:** 3:12
- **Panel Attachment:** Exposed Fastening System
- **Gauges:** 26 (standard); 22, 24, 29 (optional)
- **Finishes:** Smooth (standard); Embossed (optional)
- **Coatings:** Galvalume Plus®, Signature® 200, Signature® 300



PROJECT: Legacy Junior High School LOCATION: Layton, UT PANEL PROFILE: PBU & Artisan® Series COLOR: Laurel Green & Tundra

PBU

The PBU panel is an exposed fastener system that can be used for both roof and wall applications and can be installed directly over purlins or joists. PBU offers the versatility of being used in both vertical and horizontal applications to give designers a contemporary appearance for their building project. PBU is recommended for 1:12 or greater roof slopes.

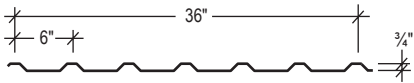
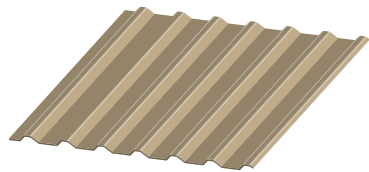

Product Specifications

- **Applications:** Roof and Wall
- **Coverage Width:** 36"
- **Rib Spacing:** 6" on Center
- **Rib Height:** 3/4"
- **Minimum Slope:** 1:12

- **Panel Attachment:** Exposed Fastening System
- **Gauges:** 26 (standard); 22, 24, 29 (optional)
- **Finishes:** Smooth (standard); Embossed (optional)
- **Coatings:** Galvalume Plus®, Signature® 200, Signature® 300

AVP

The AVP panel is used for wall application and features pencil ribs, providing improved aesthetics to building design.

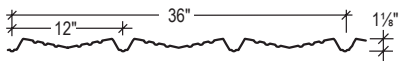
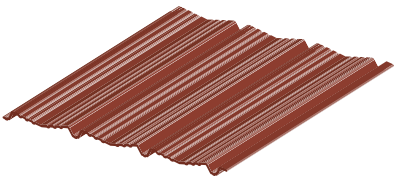

Product Specifications

- **Application:** Wall
- **Coverage Width:** 36"
- **Rib Spacing:** 12" on Center
- **Rib Height:** 1 1/8"

- **Panel Attachment:** Exposed Fastening System
- **Gauges:** 26 (standard); 22, 24, 29 (optional)
- **Finishes:** Smooth (standard); Embossed (optional)
- **Coatings:** Galvalume Plus®, Signature® 200, Signature® 300

Structural Systems



LITEFRAME®

Flexibility is the key to establishing discriminating profiles for mansard and fascia applications. LiteFrame® gives the designer total control to create shapes that enhance a building's character. Virtually any combination of hat sections, channel sections and sub-girts can be made, allowing the designer to make a statement with stature and style.

This light-gauge structural framing was designed for preformed metal panels. MBCI precision roll forms LiteFrame® in 20-foot lengths, but custom lengths are available. Hat sections and channel sections are easily assembled to make strong structural-type framing members.

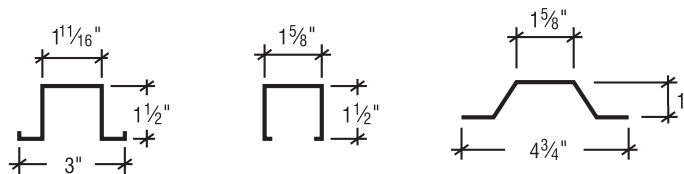

STANDARD AND CUSTOM STRUCTURAL SHAPES

MBCI manufactures a complete line of structural shapes roll-formed to dimensions common to the metal building industry. Additionally, custom shapes can also be formed to accommodate specific project requirements.

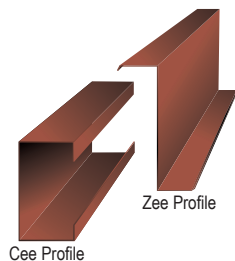

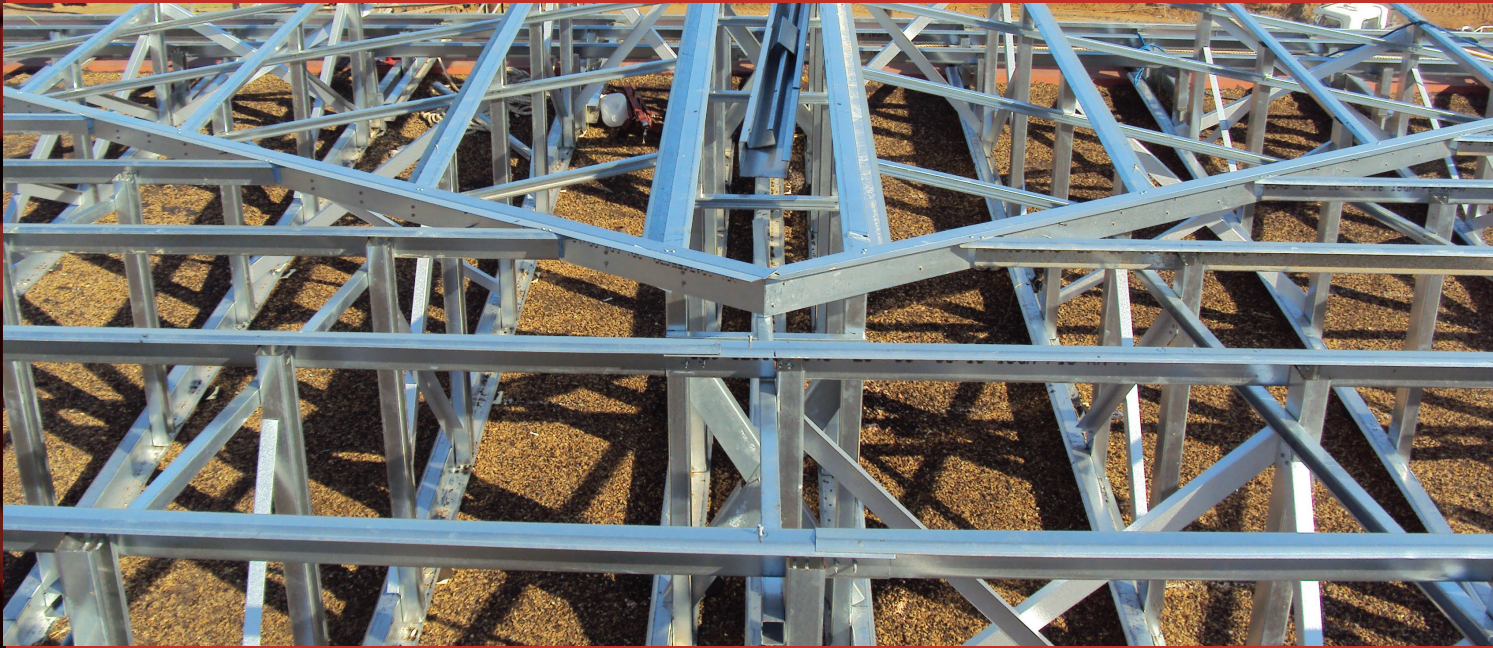

Retrofit Solutions

Whether your current roof is leaking, has problematic rainwater discharge, expensive maintenance costs, deficient energy efficiencies or all of these issues, MBCI's NuRoof[®] Retrofit System can help.



BEFORE



DURING



AFTER

PROJECT: Dallas County Waste Water Treatment Facility **LOCATION:** Dallas, TX
PANEL PROFILE: BattenLok® HS with a NuRoof® Retrofit System **COLOR:** Champagne Metallic

The NuRoof® framing system utilizes light-gauge (16 ga. to 12 ga.) steel framing installed directly over the existing roof's framing members to create a sloped plane. Regardless of whether your roof substrate is steel, wood or concrete, MBCI's NuRoof® system can be employed to satisfy the building owner's requirements. MBCI has the experience required to design a retrofit framing system that will comply with the original load requirements of the existing roof. The NuRoof® framing system has been designed to allow for a UL 90 rating using certain spacing requirements as well as meeting a variety of live and wind load requirements.

The existing roof's physical footprint, framing system and other rooftop conditions will most likely determine the new roof's geometry. A low-sloped application is typically driven by economy and designed to discharge rainwater from the roof. High-slope applications are designed to improve and update the look of an existing building in conjunction with improving the performance of the roof.

Once a NuRoof® framing system has been installed, one of MBCI's standing seam metal roofs is typically installed, creating a ventilated attic space while providing an architecturally appealing roof.

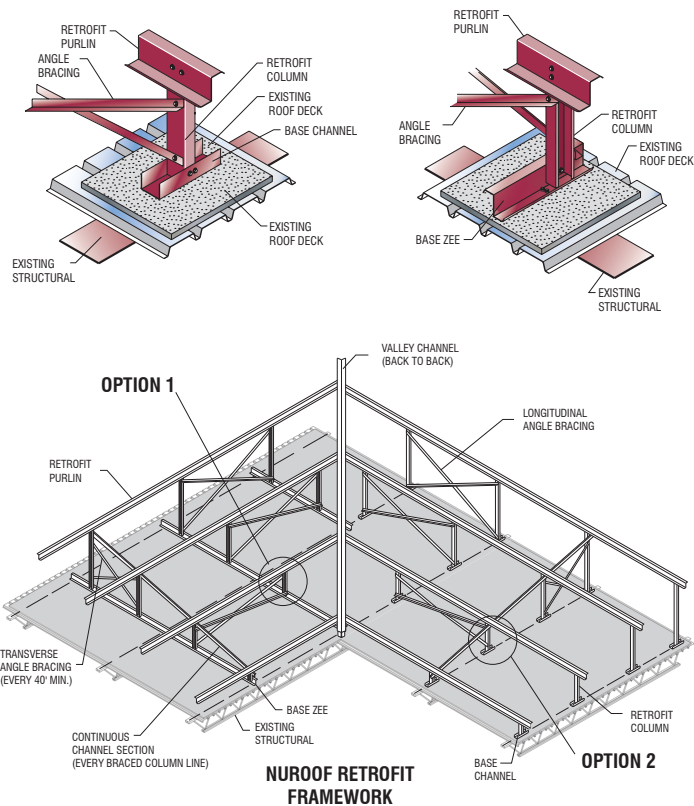



Service That Makes a Difference

MBCI was founded on its commitment to service. The additional effort from our staff sets MBCI apart from the competition. MBCI's Project Service team is staffed and prepared to provide professional assistance to the architectural and contracting communities. From the initial project concept, Project Services will assist in developing budget criteria and product selection as well as estimating and shop drawings.



**AIA
CONTINUING
EDUCATION**

MBCI's educated sales personnel are authorized to conduct AIA Continuing Education classes for the many courses we offer. Contact us by phone or through our website to schedule a meeting or lunch-and-learn today.

**CERTIFIED
INSTALLER
PROGRAM**

The MBCI Certified Installer courses cover every aspect of putting our sophisticated systems on your roof, from materials and handling, weathertightness and technical requirements to installation steps and specific detail conditions.

**SINGLE SOURCE™
WARRANTY**

When you specify one of MBCI's Single Source™ Warranties, you can have confidence that your project will be covered by the most comprehensive warranty available. MBCI will conduct timely inspections to guarantee that the approved details are being used and the roof is being properly installed. Any discrepancies found during these inspections that would prevent issuance of the warranty will be quickly brought to the architect's attention. Should a leak occur after the warranty has been issued, the owner can rely on MBCI to handle.



PROJECT: Lester E. Palmer Events Center LOCATION: Austin, TX PANEL PROFILE: SuperLok® COLOR: Galvalume Plus®

GREEN BUILDING BENEFITS

MBCI's metal panels are energy efficient, recyclable, durable, lightweight and cost-effective. Our panels are comprised of 25 percent to 35 percent recycled materials and our single skin panels are virtually 100 percent recyclable.

Cool metal roofing provides energy savings, offering both economical and environmental benefits. As a proud ENERGY STAR® Partner, our cool roof colors have reflectivity performance that met ENERGY STAR criteria for roof pitches greater than 2:12.

Our insulated metal panels (IMPs) have high R-values, which provide superior thermal performance and reduced energy consumption, allowing for smaller greenhouse gas emissions and reduced energy costs for building owners. IMPs also mitigate thermal drift, which is common when using unfaced polyisocyanurate rigid board insulation.

IMPs qualify as continuous insulation (ci) where required by the International Energy Conservation Code® (IECC) and ASHRAE 90.1. This allows for insulation to be free from significant thermal bridging. And, because of their unique self-sealing side joints, IMPs also function as an important part of a Continuous Air Barrier (CAB) system.

TRIM & FLASHING

All trim and flashing is available in the same gauge and finish as our panel offerings. A complete selection of standard trim and made-to-specification flashing in lengths up to 20 feet, three inches is available upon request. All flashing is designed to minimize exposed fasteners.

TECHNICAL INFORMATION

MBCI conforms to industry-accepted metal and finish coating standards. Physical properties are available upon request. MBCI is committed to an aggressive, independent physical testing program to continually comply with guidelines on water penetration, uplift ratings and structural performance.

MATERIALS & COATINGS

The base metal is 22-, 24- or 26-gauge steel manufactured from either high-strength Galvalume® produced to ASTM A792/A792M-AZ50 or AZ55, Grade 50 or HDG produced to ASTM A653/A653M-G90 structural aluminum. Finishes include baked enamel, urethane and Plastisol. All materials are available smooth or stucco-embossed.

All metal architectural panels have wide, flat surfaces to meet the demands of today's design. While MBCI has recognized and responded to this requirement, we have a responsibility to advise that a wide and perfectly flat appearance is not always possible. In some wide products, panel distortion—called oil canning—may occur and require additional aesthetic tolerance and/or additional support behind the panel face. Heavier gauges, narrower widths, striations and embossing minimize oil canning.

PAINT FINISHES

MBCI offers one of the largest color selections in the industry. Each of our paint colors qualifies as a cool roof on sloped roofs above 2:12. Our applied finishes work as an excellent alternative to masonry or tilt-wall construction and are available on our insulated metal panels.

SIGNATURE® 300/SIGNATURE® 300 METALLIC

This fluorocarbon paint system combines ceramic pigmentation with polyvinylidene fluoride (70 percent of resin solids) for a superior, long-lasting finish. Outstanding performance and durability are achieved through this proprietary resin technology. Signature® 300 is recognized as providing unsurpassed performance in critical areas such as color retention, film erosion rate and chemical resistance.

SIGNATURE® 200

Signature® 200 is a thermoset coating system composed of polyester resin modified by copolymerization with a functional silicone resin intermediate. With high quality ceramic pigmentation, Signature® 200 offers optimum exterior protection plus superior resistance to chemical corrosion and ultraviolet radiation. Signature® 200 represents the most sophisticated silicone polyester coating system in the industry.

PAINT WARRANTIES

Forty-year limited paint warranties are available upon written request and project qualification for all paint colors except Brite Red, which has a 25-year warranty. A 10-year warranty is available for applied finishes. (Outside the continental United States, please inquire.)



HOUSTON | 281.407.6915
ADEL, GA | 888.514.6062
ATLANTA | 678.337.1619
ATWATER, CA | 209.445.3891

ENNIS, TX | 469.256.8255
INDIANAPOLIS | 317.364.4329
LUBBOCK, TX | 806.224.2724

MEMPHIS, TN | 662.298.2337 OKLA-
HOMA CITY | 405.492.6968
PHOENIX | 480.630.3022

ROME, NY | 315.371.4330
SALT LAKE CITY | 385.715.2952
SAN ANTONIO | 210.888.9768



Descriptions and specifications contained herein were in effect at the time this publication was approved for printing. In a continuing effort to refine and improve products, MBCI reserves the right to discontinue products at any time or change specifications and/or designs without incurring obligation. To ensure you have the latest information available, please inquire or visit our website at www.mbc.com. Application details are for illustration purposes only and may not be appropriate for all environmental conditions, building designs or panel profiles. Projects should be designed to conform to applicable building codes, regulations and accepted industry practices. If there is a conflict between this manual and project erection drawings, the erection drawings will take precedence. MBCI's insulated metal panel product line is manufactured by Metl-Span.